

*Step-by-step method for installing your own*

# CHAIN LINK FENCE

Residential ( Homes | Yards | Swimming Pools )

**SIMPSON'S**  
**FENCE (LONDON) LTD.**  
"The Fence People Since 1950"

FENCE (LONDON) LTD.

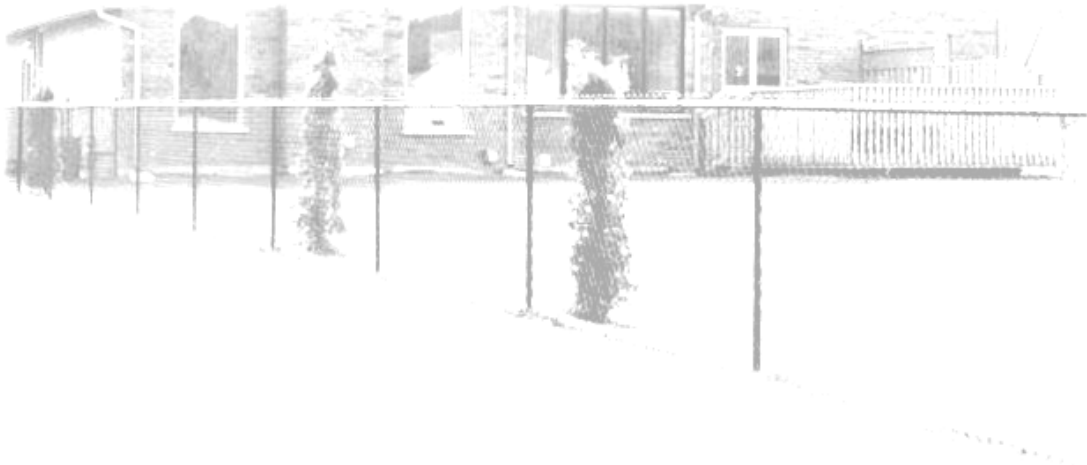

*3 locations to serve you across southwestern Ontario!*

320 Exeter Road  
London, Ontario N6L 1A3  
P: 519-680-7099  
F: 519-680-0396  
[www.simpsonsfence.ca](http://www.simpsonsfence.ca)

1030 Richmond Street  
Chatham, ON N7M 5J5  
P: 519-354-0540  
F: 519-351-8557  
[www.simpsonsfence.com](http://www.simpsonsfence.com)

464 Jutras Street N  
Tecumseh, ON N8N 5C5  
P: 519-727-8754  
F: 519-727-8759  
[www.simpsonsfence.com](http://www.simpsonsfence.com)

## HOW TO INSTALL CHAIN LINK FENCE

# WHAT YOU NEED



### RECOMMENDED TOOLS

- Post Hole Digger
- Pipe Cutter / Hacksaw
- Shovel
- Wheelbarrow
- ½" & 9/16" Wrench / Socket
- String Line & Stakes
- Line Level
- Carpenter's Level
- Fence Stretcher
- Pliers
- Safety Glasses
- Work Gloves

**SIMPSON'S**  
**FENCE (LONDON) LTD.**  
"The Fence People Since 1950"

## Before you dig!

***Don't take the risk. Get a free locate.  
IT'S THE LAW!***



Before you dig, even if it's just with a shovel, submit your locates to Ontario1Call to ensure safe digging! This website allows you to submit your locate requests, drawings, and any other information regarding the work you are doing online. Locators will be contracted once submitted and professionals will be on site to clear or mark any lines / cables that may be under the area you are looking to dig. This process takes up to 7 business days and you can also look on the Ontario1call website to check the status of your locates.

**Ontario 1-Call: phone: 1-800-400-2255 / [www.on1call.com](http://www.on1call.com)**

## STEP 1 – PREPARE YOUR FENCE LAYOUT

1. Determine location of corner and end posts and mark their location with upside down marking paint.
2. Drive stakes a foot or two away from where you want corner and end posts to be located; this will allow you to drill/ dig holes without obstructions. It may also allow you to 'drop' the string while excavating for holes. Be careful not to bump or move stakes. If you remove the string to excavate holes, take care to re-stretch the string line back the way it was prior to removing.
3. Stretch string line tight between these stakes. This string will represent the location of the fence and serve as a guide string as you set posts.
4. Intermediate stakes may be required for longer stretches of fence. Be sure to pull string taut; a string which sags or moves with the wind will cause posts to be set incorrectly. **Keep in mind, the fence can only be as straight as the guide string.**
5. Determine location of gate posts and mark their location with upside down marking paint.
6. Measure each stretch of fence. Chain link posts are typically spaced with a maximum of ten feet apart. For aesthetic reasons, space posts evenly, but **do NOT exceed ten feet between posts**. If you plan on installing privacy slats or another type of material that will increase wind load, consider using 8' or 6' post spacing.

### Layout:

#### Three-Four-Five Triangulation Method to Squaring Corners:

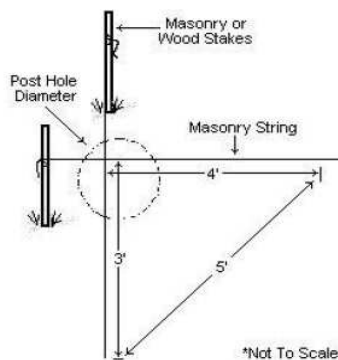

#### Creating Square Corners Using the 3-4-5 method:

- 1.) Stretch string down two adjacent sides as shown in drawing.
- 2.) Measure and make mark 3' down one line.
- 3.) Measure and make mark 4' down other line.
- 4.) Measure diagonally between two marks and adjust lines to achieve 5'.

\*For further accuracy, use measurements in multiples of 3-4-5, such as 6-8-10 etc.



When preparing your fence layout, be sure that the desired location of fence lines does not exceed property lines. **This is very important.** If the property line locations are not known, a survey may need to be performed. It is recommended that all posts are set at least 4" inside of the property line to avoid encroaching onto adjoining property with the concrete foundations. This may be done by stretching string or creating chalk lines on the property line and setting posts approximately 4" inside of them.

## STEP 2 – SETTING TERMINAL POSTS

1. Dig terminal post holes 6" in diameter and 36" to 42" deep with sloping sides. Leave concrete 4" to 6" below grade and backfill with dirt.
2. Using your method for marking, mark the ground line on the posts. The terminal posts will be 2" higher than the height of the fabric.
3. Set terminal post in concrete using either premixed concrete or mixing your own as follows: **(1 part cement, 2 parts sand, and 4 parts gravel)**. Be sure to leave concrete approximately 6" below ground level. Posts have to be plumb and set at correct height.

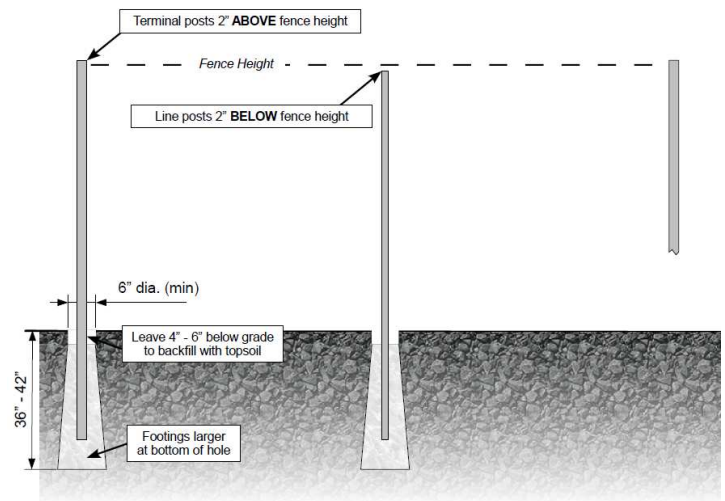

## STEP 3 – SETTING LINE POSTS

1. Mark the grade line on all of the posts measuring from the top down.
2. Measure the distance between terminal posts and check line post spacing chart for exact distance to allow between line posts.
3. Line posts are to be set in concrete leaving approximately 6" below ground level. Make sure line posts are plumb, aligned with centre of terminal posts, and at the correct height.
4. Stretch a line of string from outside of the terminal post to the outside of the next terminal post (be sure the concrete has set up sufficiently so as not to lose plumb).
5. The line post holes should be lined up so that when they are set in the center of their holes, their centers will line up with the terminal post centers. This means the outside faces of the line posts will be about 1/4" inside of the line stretched between the outside of the terminal posts.
6. Dig the line post holes and set the line posts.
7. Stretch your string line 2" – 3" above grade and use as a guide to align height of line posts in relation to grade line marking applied to posts in step #1. **(If necessary, to adjust height of any post either up or down, simply raise or lower post before concrete sets and use your level to keep plumb while adjusting post height).**

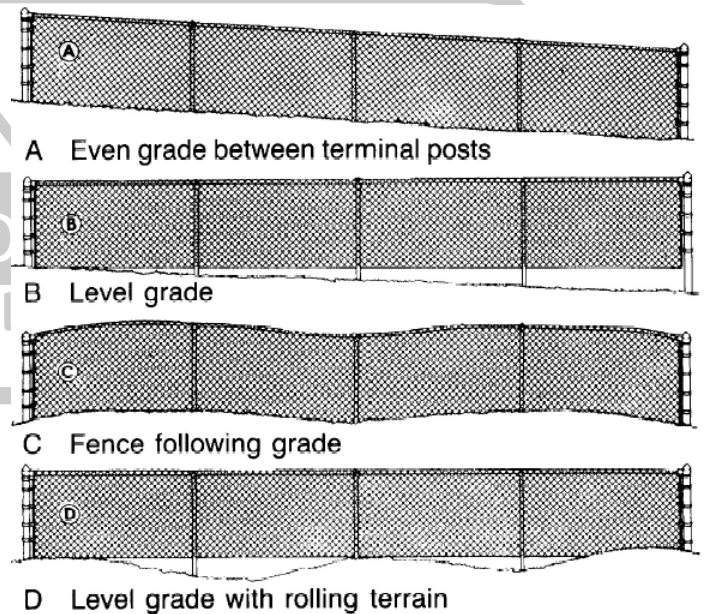

## STEP 4 – APPLYING FITTINGS TO TERMINAL POSTS

1. Check your material list and fittings identification chart. After the posts have been installed and the concrete allowed to set (**typically 48 hours minimum**), slip tension and brace bands on terminal posts.
2. The tension bands should be spaced approximately 10"-12" apart.
3. Do not spread or distort bands. All bolt heads for bands are on the outside of fence and the threaded ends are on the inside.
4. Apply all terminal post caps

## STEP 5 – APPLY TOP RAIL AND TENSION WIRE

1. Place line post caps on each line post. **The flat side of the eye top should be on the outside of the fence.**
2. Insert 1 length of top rail through the eye top closest to the terminal post. Slip the rail end onto the end of the top rail and attach it to the terminal post by using the centre band and 5/16" x 1-1/4 carriage bolt.
3. Continue by forcing the lengths of swedge end top rail together through the line post tops. Upon reaching the next terminal post, measure and cut the top rail to fit tightly between the last length of top rail and end.
4. Fasten end to the terminal post. Continue steps 3 & 4 until all top rails have been installed.
5. Wrap tension wire once around bottom of terminal post.
6. Twist several times to secure.
7. Run wire along outside of fence; wrapping snugly and twisting at next terminal post.
8. Tighten bottom wire by applying a Z-bend or installing & tightening a turnbuckle at one end.

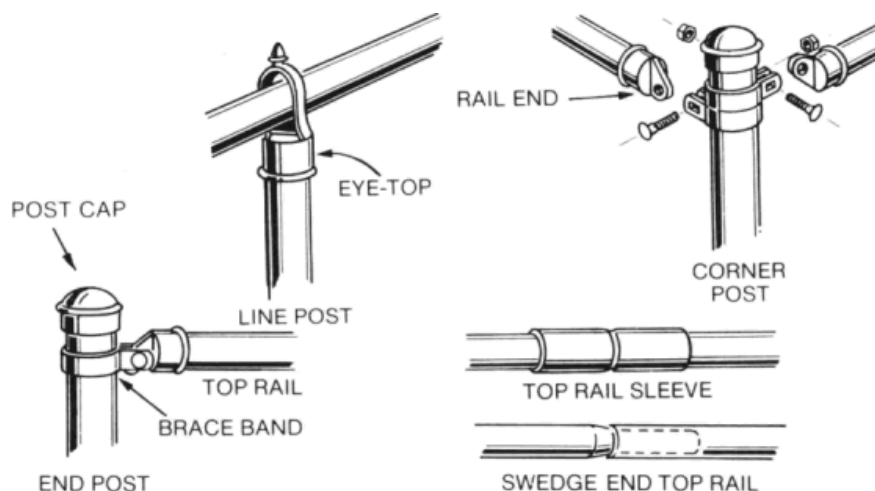

## **STEP 6 – HANGING THE FABRIC**

1. Starting at the terminal post, unroll chain link fabric on the ground along outside of the fence line to the next terminal post. Slide a tension bar through the first row of chain link diamonds. Fasten evenly spaced tension bands (already on the post) to the tension bar, fabric combination using 5/16" x 1-1/4" carriage bolts with heads to outside of fence.
2. Walk along the fabric and stand it up against the fence frame, taking out the slack as you go. Loosely attach fabric to top rail with a few cut pieces of bracewire to hold in place. Separate enough fabric from the roll to span the opening between terminal posts.



### ***How to remove excess fabric:***

*Remove the excess fabric with pliers by opening the top and bottom knuckles of a single strand of wire at the desired point of separation. Unwind the strand up through the links until fabric comes apart.*



### ***How to splice sections of fabric:***

*Using a single strand of wire, removed from end of the fabric, join the two sections by winding the loose strand down, cork screw style, through the end link. Join and tighten the knuckles at the top and bottom to secure. **[Note: before sections can be spliced, a single strand may have to be removed to provide proper mesh].***



**FENCE (LONDON) LTD.**  
"The Fence People Since 1950"

## **STEP 7 – STRETCHING FENCE FABRIC**

1. Temporarily insert a tension bar about 3 feet inside the unattached end of fabric
2. Securely fasten one end of the fence stretcher to the tension bar and the other end to the terminal post.
3. Stretch the fabric. The top of the fabric should be approximately ½” high than the top rail to assure proper height. The correct fabric tension should allow a slight amount of give when squeezed by hand.
4. Adjust fabric to exact length by adding or removing wire.
5. Insert a tension bar at the end of fabric and connect to tension bands on terminal post.
6. After removing the fence stretcher tie fabric securely with tie wires spaced approximately 18” apart along top rail and line post.
7. Attach fabric to bottom wire, no more than 24” apart or as needed (use a tie at each line post, clipping into bottom knuckle or attach with hog rings or ties if required).

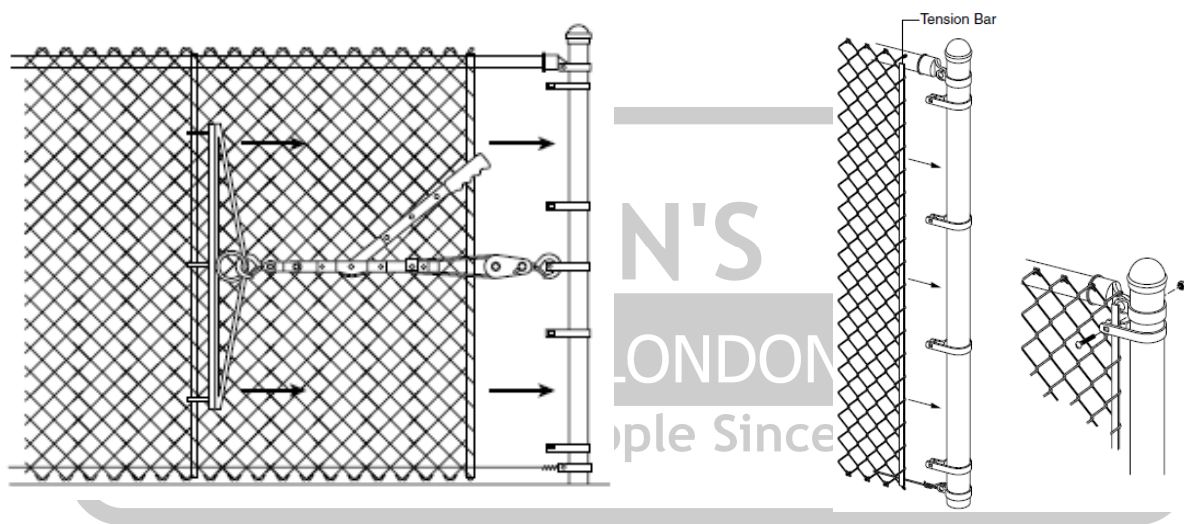

### **How to make an angle stretch**

*If you need to stretch chain link up or down an incline, you will need to make an angle stretch. Pull the chain link fabric until top or bottom, what ever is the shortest, reaches the terminal post. Insert the tension bar at an angle that is parallel to the terminal post. Remove the excess wire by cutting the strands that form the diamond at the tension bar, leaving them long enough to bend over the bar. Do not cut every wire. The number of cuts depends on the degree of angle. On extreme angles, a longer tension bar may be required.*

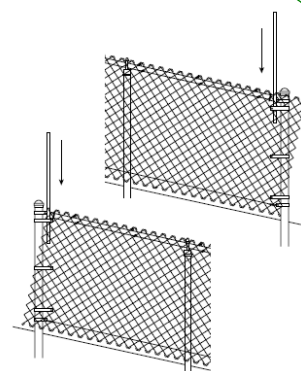

## STEP 8 – HANGING THE GATE

**Note:** The same installation procedures are required for both single and double swing gates.

1. Apply gate post hinges approximately 8" from the top and the bottom of the gatepost with the top hinge bolt pointing down and the bottom hinge bolt pointing up. This will prevent gate from being removed.
2. Tighten all bolts securely.
3. Apply gate frame hinges to the gate frame. Loosely fasten the bolts so they can be easily adjusted on the gate frame.
4. Hang the gate(s) in place so that the bottom of the gate has approximately 2" of ground clearance.
5. Tighten the bolts on the bottom hinge first, and then adjust and tighten the bolts securely at the top.
6. Position the gate latch at a convenient height (**minimum 48"** for pool fence gates in some areas – consult your local bylaws!).
7. Tighten bolts securely.

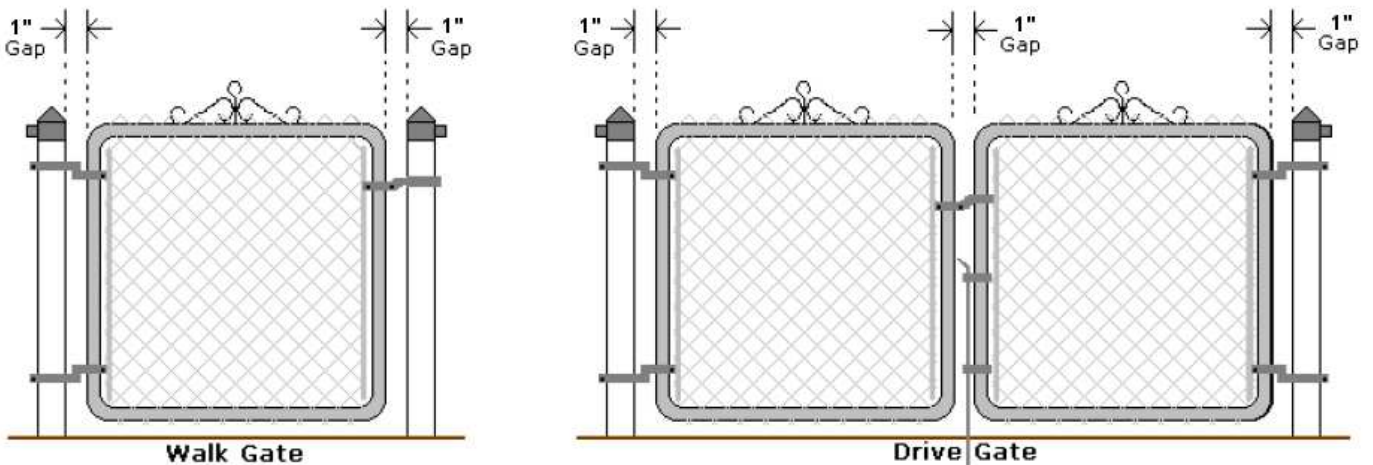
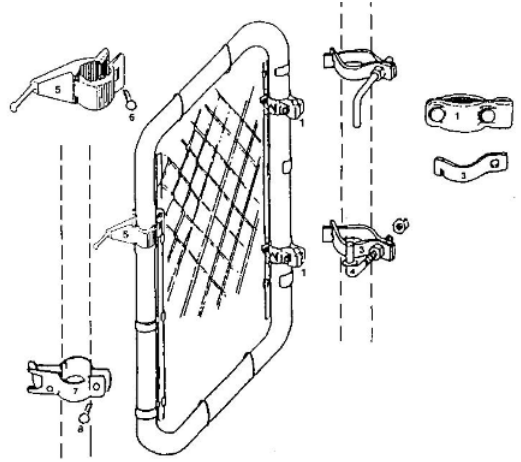

### Spring Closers

Spring closers can be ordered with a residential gate or purchased separately for retrofit on an existing gate. They are normally required for any swimming pool installations and are recommended for applications that require a gate to be closed at all times.

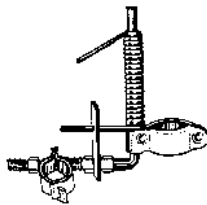



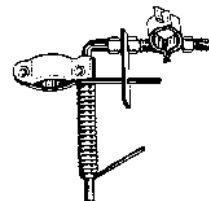











Note: in some applications, the spring closure may need to be installed upside down. This is dependant on which way the gate is hung and swinging.



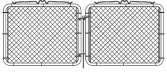

## **MATERIALS NEEDED**

<i>Item Description</i>	<i>Quantity To Use</i>	<i># Needed</i>
 Fabric (50' per roll)	<i>Divide total footage by 50 and round up</i>	<input type="text"/>
 Top Rail (1 ¼" x 10'L swaged end)	<i>Divide total footage by 10, round up</i>	<input type="text"/>
 Line Post	<i>Divide total footage by 10, round up</i>	<input type="text"/>
 Terminal Post	<i>1 per end/corner, 2 per gate</i>	<input type="text"/>
 Loop Caps (match Line Post & Top Rail sizes)	<i>Use 1 per line post</i>	<input type="text"/>
 Tension Bar	<i>1 per end/gate post, 2 per corner post (1 per hookup)</i>	<input type="text"/>
 Centre Band (Brace Band)	<i>1 per tension bar</i>	<input type="text"/>
 Rail End	<i>1 per centre band</i>	<input type="text"/>
 Tension Band (Offset Band)	<i>1 per 14" of fence height @ ea hookup/tension bar</i>	<input type="text"/>
 5/16" x 1 ¼" Carriage Bolt	<i>1 per tension band or centre band</i>	<input type="text"/>
 Terminal Post Caps	<i>1 per terminal post</i>	<input type="text"/>
 Hook Tie Wires	<i>1 per foot of fence (100 pcs per bag)</i>	<input type="text"/>
Wood Hookup Kit (4 wood-lag screw bolts + modified rail end cap)	<i>1 per hook-up to wood post (needs tension bar)</i>	<input type="text"/>
 Walk Gate (42" or 48" OP)	<i>As needed, include hardware</i>	<input type="text"/>
 Double Gate (72" / 84" / 96" /120" OP)	<i>As needed, include hardware</i>	<input type="text"/>
 Spring Closer Upgrade Hardware	<i>1 per any single gate to convert to self-closing</i>	<input type="text"/>
 Concrete (pre-mixed)	<i>1-2 bags per hole</i>	<input type="text"/>

## LAYOUT & POST SPACING CHART (10' MAX)

Length Of Line	Spacing (OC)	Length Of Line	Spacing (OC)	Draw Your Layout Here										
30'	10'	70'	10'											
31'	7' 9"	71'	8' 11"											
32'	8'	72'	9'											
33'	8' 3"	73'	9' 2"											
34'	8' 6"	74'	9' 3"											
35'	8' 9"	75'	9' 5"											
36'	9'	76'	9' 6"											
37'	9' 3"	77'	9' 8"											
38'	9' 6"	78'	9' 9"											
39'	9' 9"	79'	9' 11"											
40'	10'	80'	10'											
41'	8' 2"	81'	9'											
42'	8' 5"	82'	9' 1"											
43'	8' 7"	83'	9' 3"											
44'	8' 10"	84'	9' 4"											
45'	9'	85'	9' 5"											
46'	9' 2"	86'	9' 7"											
47'	9' 5"	87'	9' 8"											
48'	9' 7"	88'	9' 9"											
49'	9' 10"	89'	9' 11"											
50'	10'	90'	10'											
51'	8' 6"	91'	9' 1"											
52'	8' 8"	92'	9' 2"											
53'	8' 10"	93'	9' 4"											
54'	9'	94'	9' 5"											
55'	9' 2"	95'	9' 6"											
56'	9' 4"	96'	9' 7"											
57'	9' 6"	97'	9' 8"											
58'	9' 8"	98'	9' 10"											
59'	9' 10"	99'	9' 11"											
60'	10'	100'	10'											
61'	8' 9"	101'	9' 2"											
62'	8' 10"	102'	9' 3"											
63'	9'	103'	9' 4"											
64'	9' 2"	104'	9' 5"											
65'	9' 3"	105'	9' 7"											
66'	9' 5"	106'	9' 8"											
67'	9' 7"	107'	9' 9"											
68'	9' 9"	108'	9' 10"											
69'	9' 10"	109'	9' 11"											

### NOTES

---



---



---

